

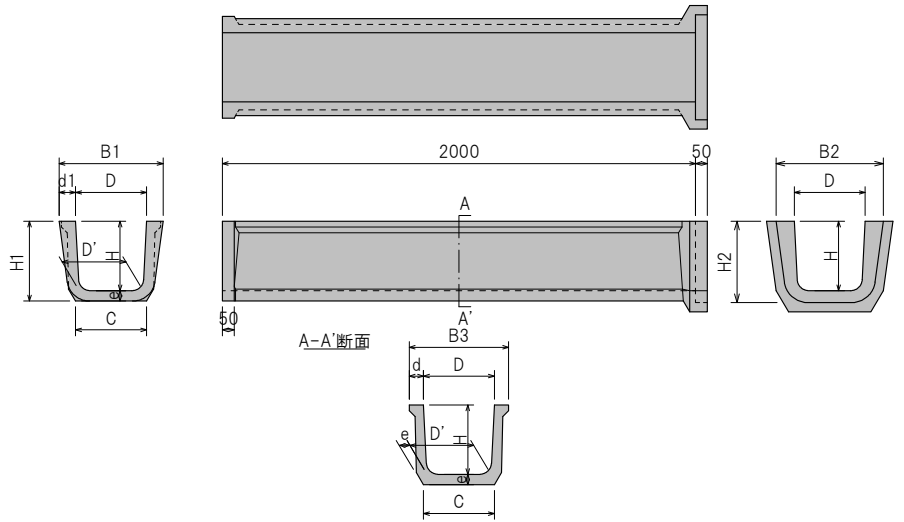

N-U型水路

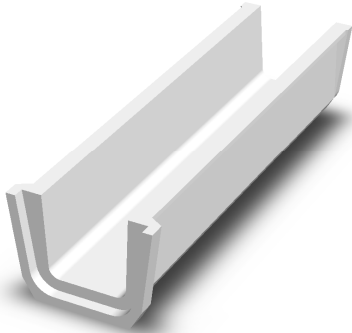

呼び名	寸法 (mm)												参考重量 (kg)
	D	H	B1	B2	B3	C	D'	H1	H2	d	d1	e	
200×200	200	200	320	334	300	210	180	240	247	50	60	40	128
250×250	250	250	370	384	350	255	225	290	297	50	60	40	156
300×300	300	300	440	454	420	300	270	345	352	60	70	45	207
400×400	400	400	570	584	550	390	360	450	457	75	85	50	303
450×450	450	450	630	644	600	435	405	500	507	75	90	50	342
500×500	500	500	690	704	660	480	450	555	562	80	95	55	406
550×550	550	550	750	764	720	525	495	605	612	85	100	55	444
600×600	600	600	820	834	790	580	540	660	667	95	110	60	524
700×600	700	600	890	904	860	695	640	665	672	80	95	65	590
800×600	800	600	990	1004	960	795	740	665	672	80	95	65	630
700×700	700	700	910	924	880	689	630	770	777	90	105	70	707
800×700	800	700	1010	1024	980	789	730	770	777	90	105	70	742
900×700	900	700	1110	1124	1080	889	830	770	777	90	105	70	777
800×800	800	800	1040	1054	1000	788	720	880	887	100	120	80	897
900×800	900	800	1140	1154	1100	888	820	880	887	100	120	80	937
1000×800	1000	800	1240	1254	1200	988	920	880	887	100	120	80	977
1200×800	1200	800	1440	1454	1400	1188	1120	880	887	100	120	80	1057
1300×900	1300	900	1570	1584	1520	1286	1210	990	997	110	135	90	1355
1000×1000	1000	1000	1300	1314	1240	985	900	1100	1107	120	150	100	1347



N-U型水路 蓋

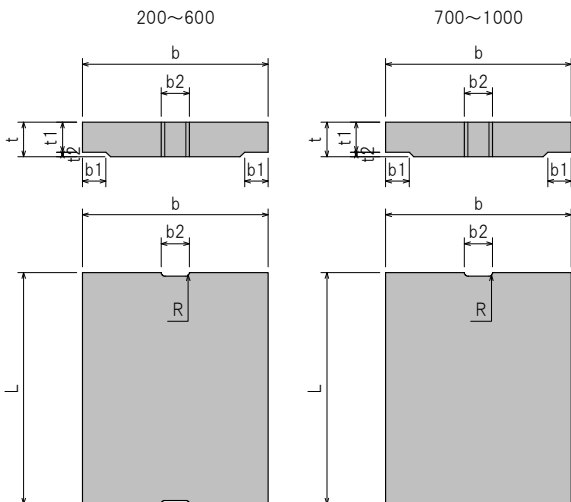

呼び名	寸法 (mm)							L	R	参考重量 (kg)
	b	b1	b2	t	t1	t2				
200用	300	55	120	55	45	10	1000	15	36	
250用	350	55	120	60	50	10	1000	15	46	
300用	420	65	120	65	55	10	1000	15	61	
400用	550	80	120	75	65	10	1000	15	92	
450用	600	80	120	75	65	10	1000	15	101	
500用	660	85	120	80	70	10	1000	15	120	
600用	790	100	120	85	75	10	1000	15	153	
700用	860	85	120	90	80	10	1000	15	178	
800用	960	85	120	95	85	10	1000	15	210	
900用	1080	95	120	100	90	10	1000	15	249	
1000用	1200	105	120	105	95	10	1000	15	291	



N-U型水路落差工

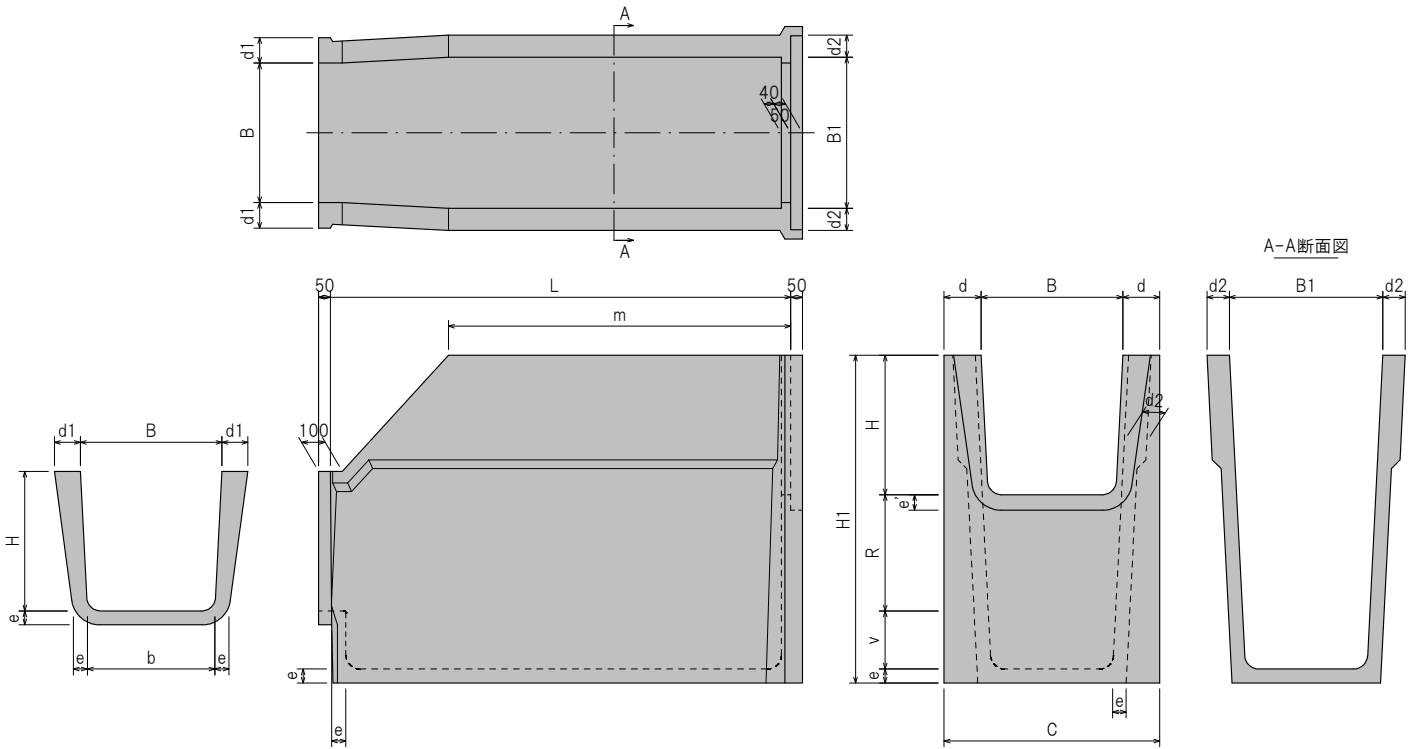

呼び名	寸法 (mm)															参考重量 (kg)
	B	H	R	B1	C	H1	L	b	d	d1	d2	e	e'	m	v	
300×300-100	300	300	100	310	534	645	2000	270	117	70	60	45	52	1700	200	400
300×300-200	300	300	200	320	534	745	2000	270	117	70	60	45	52	1500	200	458
300×300-300	300	300	300	330	534	845	2000	270	117	70	60	45	52	1300	200	512
300×300-400	300	300	400	340	534	945	2000	270	117	70	60	45	52	1100	200	576
300×300-500	300	300	500	350	534	1045	2000	270	117	70	60	45	52	900	200	600
400×400-100	400	400	100	410	664	750	2000	360	132	85	75	50	57	1740	200	531
400×400-200	400	400	200	420	664	850	2000	360	132	85	75	50	57	1580	200	608
400×400-300	400	400	300	430	664	950	2000	360	132	85	75	50	57	1420	200	676
400×400-400	400	400	400	440	664	1050	2000	360	132	85	75	50	57	1260	200	740
400×400-500	400	400	500	450	664	1150	2000	360	132	85	75	50	57	1100	200	797
500×500-100	500	500	100	510	784	905	2000	450	142	95	80	55	62	1780	250	711
500×500-200	500	500	200	520	784	1005	2000	450	142	95	80	55	62	1660	250	794
500×500-300	500	500	300	530	784	1105	2000	450	142	95	80	55	62	1540	250	879
500×500-400	500	500	400	540	784	1205	2000	450	142	95	80	55	62	1420	250	954
500×500-500	500	500	500	550	784	1305	2000	450	142	95	80	55	62	1300	250	1020
600×600-100	600	600	100	610	914	1010	2000	540	157	110	95	60	67	1810	250	875
600×600-200	600	600	200	620	914	1110	2000	540	157	110	95	60	67	1720	250	953
600×600-300	600	600	300	630	914	1210	2000	540	157	110	95	60	67	1630	250	1082
600×600-400	600	600	400	640	914	1310	2000	540	157	110	95	60	67	1540	250	1174
600×600-500	600	600	500	650	914	1410	2000	540	157	110	95	60	67	1450	250	1261
700×600-100	700	600	100	710	994	1015	2000	640	147	95	80	65	72	1750	250	961
700×600-200	700	600	200	720	994	1115	2000	640	147	95	80	65	72	1600	250	1046
700×600-300	700	600	300	730	994	1215	2000	640	147	95	80	65	72	1450	250	1136
700×600-400	700	600	400	740	994	1315	2000	640	147	95	80	65	72	1300	250	1208
700×600-500	700	600	500	750	994	1415	2000	640	147	95	80	65	72	1150	250	1275



N-U型水路落差工

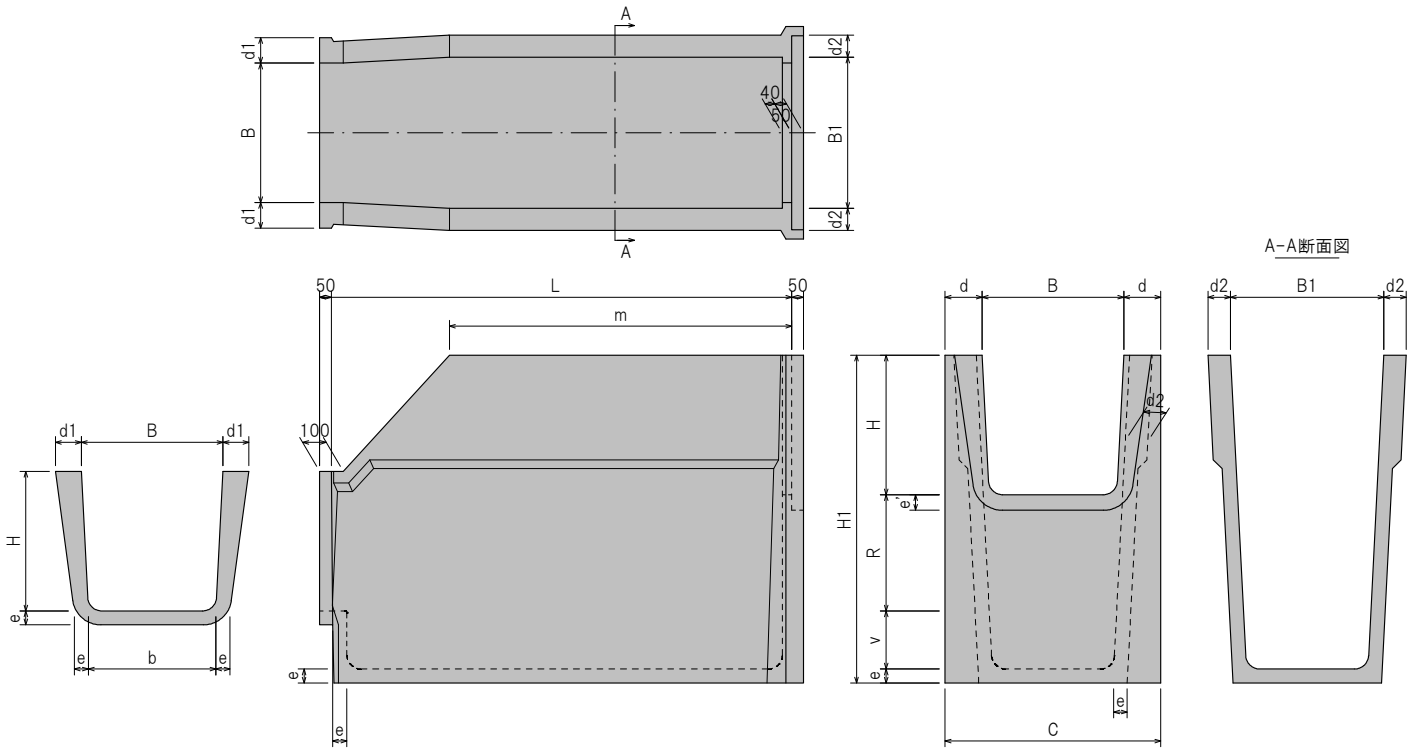

呼び名	寸法 (mm)															参考重量 (kg)
	B	H	R	B1	C	H1	L	b	d	d1	d2	e	e'	m	v	
800×600-100	800	600	100	810	1094	1015	2000	740	147	95	80	65	72	1750	250	1008
800×600-200	800	600	200	820	1094	1115	2000	740	147	95	80	65	72	1600	250	1095
800×600-300	800	600	300	830	1094	1215	2000	740	147	95	80	65	72	1450	250	1190
800×600-400	800	600	400	840	1094	1315	2000	740	147	95	80	65	72	1300	250	1265
800×600-500	800	600	500	850	1094	1415	2000	740	147	95	80	65	72	1150	250	1334
700×700-100	700	700	100	710	1024	1170	2000	630	162	105	80	70	77	1750	300	1155
700×700-200	700	700	200	720	1024	1270	2000	630	162	105	80	70	77	1600	300	1247
700×700-300	700	700	300	730	1024	1370	2000	630	162	105	80	70	77	1450	300	1347
700×700-400	700	700	400	740	1024	1470	2000	630	162	105	80	70	77	1300	300	1427
700×700-500	700	700	500	750	1024	1570	2000	630	162	105	80	70	77	1150	300	1501
800×700-100	800	700	100	810	1124	1170	2000	730	162	105	90	70	77	1750	300	1203
800×700-200	800	700	200	820	1124	1270	2000	730	162	105	90	70	77	1600	300	1298
800×700-300	800	700	300	830	1124	1370	2000	730	162	105	90	70	77	1450	300	1401
800×700-400	800	700	400	840	1124	1470	2000	730	162	105	90	70	77	1300	300	1483
800×700-500	800	700	500	850	1124	1570	2000	730	162	105	90	70	77	1150	300	1570
900×700-100	900	700	100	910	1224	1170	2000	830	162	105	90	70	77	1750	300	1251
900×700-200	900	700	200	920	1224	1270	2000	830	162	105	90	70	77	1600	300	1348
900×700-300	900	700	300	930	1224	1370	2000	830	162	105	90	70	77	1450	300	1453
900×700-400	900	700	400	940	1224	1470	2000	830	162	105	90	70	77	1300	300	1537
900×700-500	900	700	500	950	1224	1570	2000	830	162	105	90	70	77	1150	300	1616
800×800-100	800	800	100	810	1164	1280	2000	720	182	120	100	80	87	1750	300	1451
800×800-200	800	800	200	820	1164	1380	2000	720	182	120	100	80	87	1600	300	1556
800×800-300	800	800	300	830	1164	1480	2000	720	182	120	100	80	87	1450	300	1664
800×800-400	800	800	400	840	1164	1580	2000	720	182	120	100	80	87	1300	300	1752
800×800-500	800	800	500	850	1164	1680	2000	720	182	120	100	80	87	1150	300	1835



排水フリューム【2面】

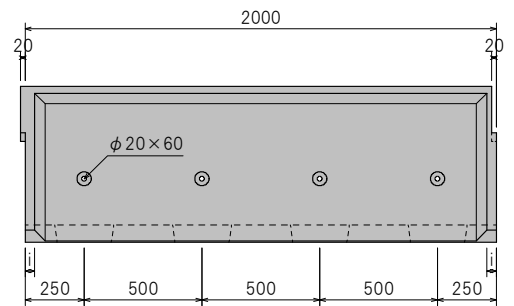
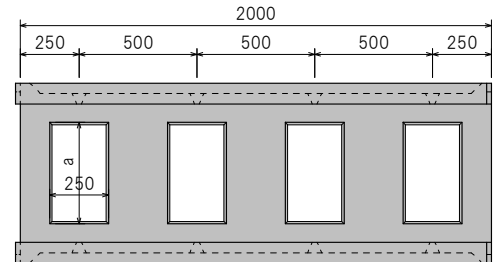
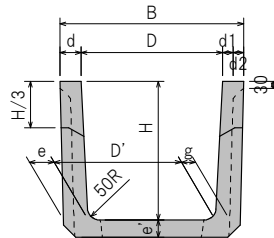
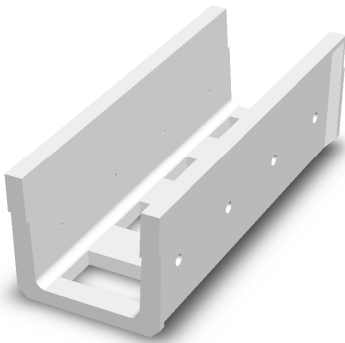

呼び名	寸法 (mm)												参考重量 (kg)
	B	D	D'	H	d	d1	d2	e	e'	g	i	a	
400×400	550	400	360	400	75	40	35	85	65	50	40	240	286
500×500	660	500	450	500	80	45	35	90	70	55	40	340	378
600×600	780	600	540	600	90	45	45	105	75	60	40	440	468
700×600	880	700	640	600	90	45	45	105	75	60	40	540	486
800×600	980	800	740	600	90	45	45	105	75	60	40	640	504
900×600	1080	900	840	600	90	45	45	105	75	60	40	740	522
1000×600	1180	1000	940	600	90	45	45	105	85	60	40	840	570
1200×600	1380	1200	1140	600	90	55	35	120	95	75	40	1040	742
600×900	800	600	510	900	100	50	50	130	100	80	70	410	835
700×900	900	700	610	900	100	50	50	130	100	80	70	510	859
800×900	1000	800	710	900	100	50	50	130	100	80	70	610	883
900×900	1100	900	810	900	100	50	50	130	100	80	70	710	907
1000×900	1200	1000	910	900	100	50	50	130	100	80	70	810	931



排水フリューム【3面】

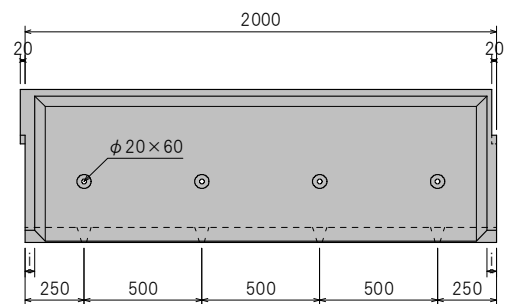
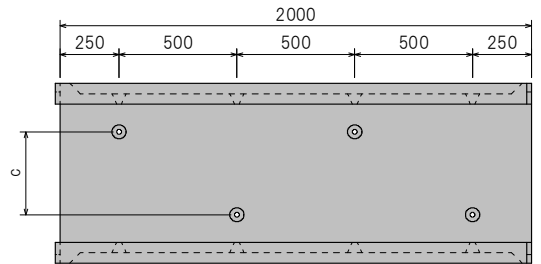
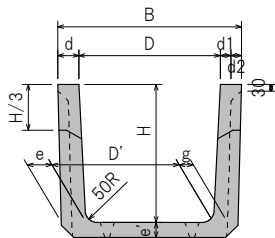
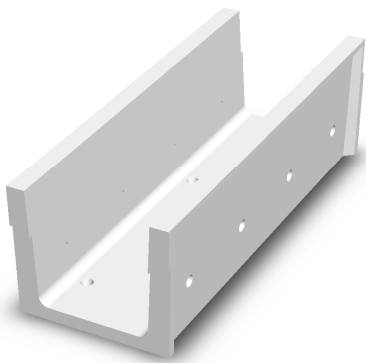

呼び名	寸法 (mm)												参考重量 (kg)
	B	D	D'	H	d	d1	d2	e	e'	g	i	C	
300×300	410	300	270	300	55	35	20	70	45	45	40	90	202
400×400	550	400	360	400	75	40	35	85	55	50	40	180	300
500×500	660	500	450	500	80	45	35	90	60	55	40	270	407
600×600	780	600	540	600	90	45	45	105	65	60	40	360	513
700×600	880	700	640	600	90	45	45	105	65	60	40	460	544
800×600	980	800	740	600	90	45	45	105	65	60	40	560	575
900×600	1080	900	840	600	90	45	45	105	65	60	40	660	606
1000×600	1180	1000	940	600	90	45	45	105	70	60	40	760	662
1200×600	1380	1200	1140	600	90	55	35	120	75	75	40	900	852
600×900	800	600	510	900	100	50	50	130	80	80	70	330	868
700×900	900	700	610	900	100	50	50	130	80	80	70	430	906
800×900	1000	800	710	900	100	50	50	130	80	80	70	530	944
900×900	1100	900	810	900	100	50	50	130	80	80	70	630	982
1000×900	1200	1000	910	900	100	50	50	130	80	80	70	730	1020



排水フリューム【DU型】

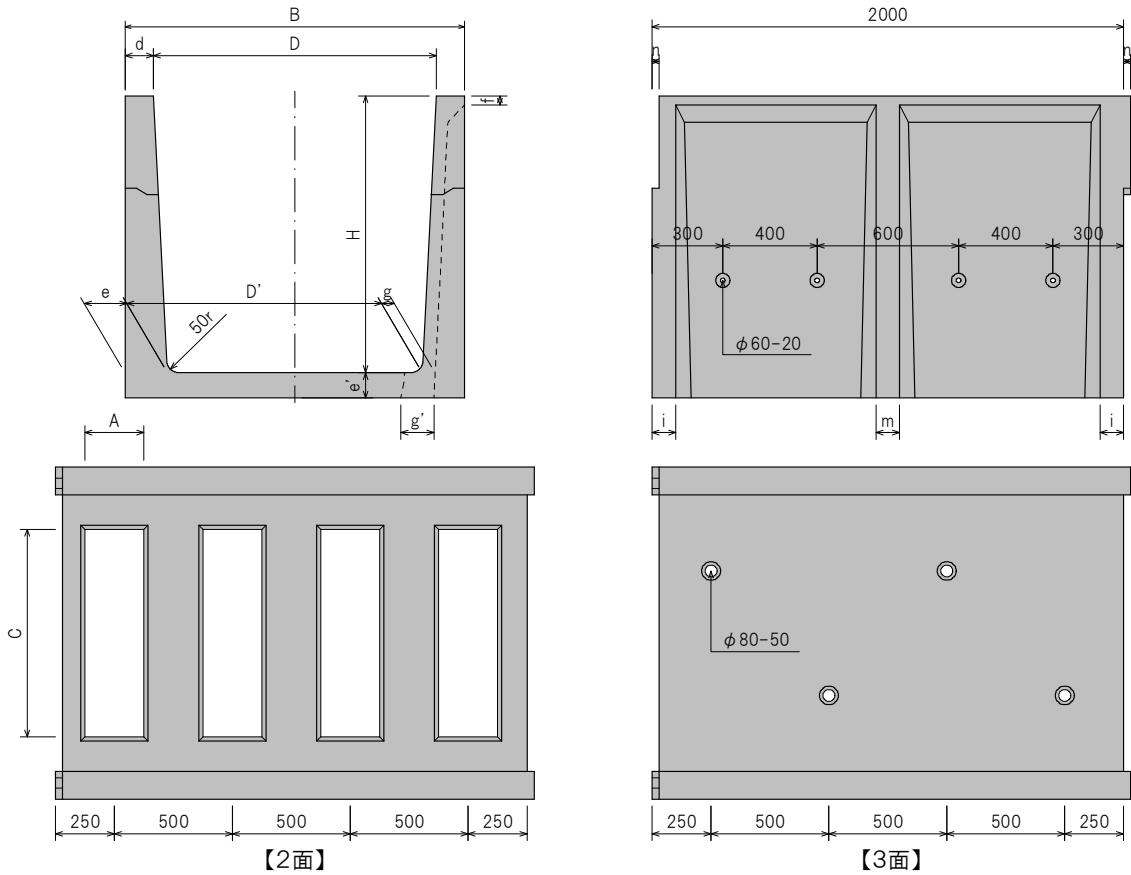

【2面】

呼び名	寸法 (mm)														参考重量 (kg)	
	B	D	H	D'	d	e	e'	f	g	g'	i	m	n	A		C
1200×900	1400	1200	900	1110	100	150	150	30	50	149	70	100	15	250	900	1022
1500×900	1700	1500	900	1410	100	150	150	30	50	149	70	100	15	250	1200	1113
2000×900	2200	2000	900	1910	100	150	150	30	50	174	70	100	15	250	1650	1300
800×1200	1040	800	1200	680	120	180	180	40	55	117	100	100	30	250	540	1293
900×1200	1140	900	1200	780	120	180	180	40	55	117	100	100	30	250	640	1332
1000×1200	1240	1000	1200	880	120	180	180	40	55	117	100	100	30	250	740	1371
1200×1200	1440	1200	1200	1080	120	180	180	40	55	137	100	100	30	250	900	1468
1500×1200	1740	1500	1200	1380	120	180	180	40	55	137	100	100	30	250	1200	1586
2000×1200	2240	2000	1200	1880	120	180	180	40	55	162	100	100	30	250	1650	1804

【3面】

呼び名	寸法 (mm)														参考重量 (kg)	
	B	D	H	D'	d	e	e'	f	g	g'	i	m	n	A		C
1200×900	1400	1200	900	1110	100	150	80	30	50	—	70	100	15	—	—	974
1500×900	1700	1500	900	1410	100	150	100	30	50	—	70	100	15	—	—	1149
2000×900	2200	2000	900	1910	100	150	110	30	50	—	70	100	15	—	—	1551
800×1200	1040	800	1200	680	120	180	110	40	55	—	100	100	30	—	—	1218
900×1200	1140	900	1200	780	120	180	110	40	55	—	100	100	30	—	—	1269
1000×1200	1240	1000	1200	880	120	180	110	40	55	—	100	100	30	—	—	1321
1200×1200	1440	1200	1200	1080	120	180	110	40	55	—	100	100	30	—	—	1424
1500×1200	1740	1500	1200	1380	120	180	110	40	55	—	100	100	30	—	—	1579
2000×1200	2240	2000	1200	1880	120	180	110	40	55	—	100	100	30	—	—	1838



排水フリューム落差工

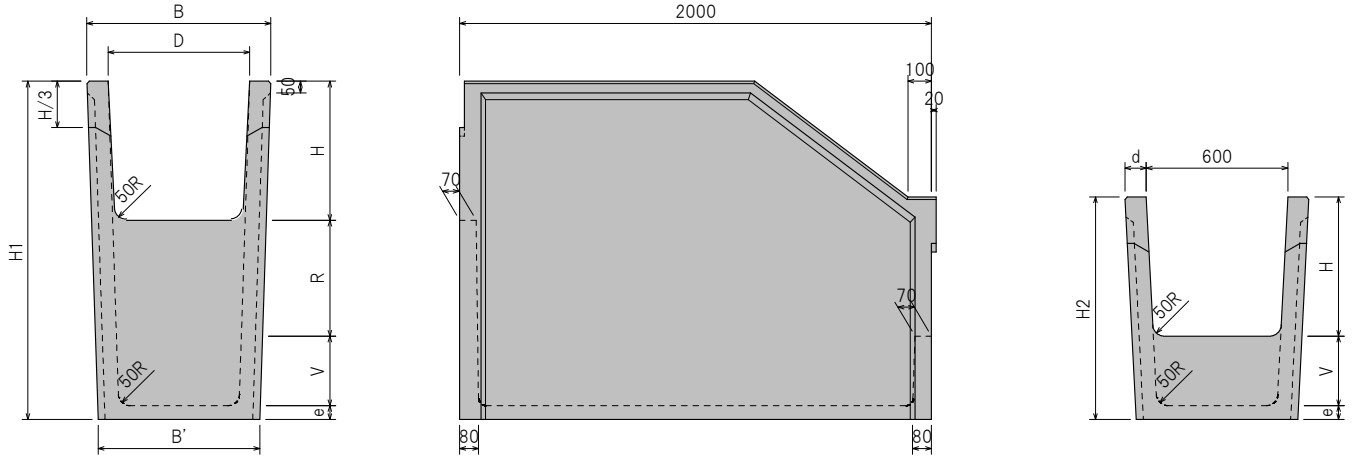

呼び名	寸法 (mm)										参考重量 (kg)
	D	H	R	B	B'	H1	H2	V	d	e	
400×400-300	400	400	300	550	490	950	650	200	75	50	474
500×500-300	500	500	300	660	590	1055	755	200	80	55	559
400×600-300	400	600	300	580	490	1260	960	300	90	60	893
600×600-300	600	600	300	780	690	1260	960	300	90	60	993
800×600-300	800	600	300	980	890	1260	960	300	90	60	1093
900×600-300	900	600	300	1080	990	1260	960	300	90	60	1143
1000×600-300	1000	600	300	1180	1090	1260	960	300	90	60	1193
1200×600-300	1200	600	300	1380	1290	1260	960	300	90	60	1293
600×900-300	600	900	300	800	680	1580	1280	300	100	80	1193
800×900-300	800	900	300	1000	880	1580	1280	300	100	80	1313
900×900-300	900	900	300	1100	980	1580	1280	300	100	80	1373
1000×900-300	1000	900	300	1200	1080	1580	1280	300	100	80	1433
1200×900-300	1200	900	300	1400	1280	1580	1280	300	100	80	1553
1500×900-300	1500	900	300	1700	1580	1580	1280	300	100	80	1733
2000×900-300	2000	900	300	2200	2080	1580	1280	300	100	80	2033
400×400-500	400	400	500	550	490	1150	650	200	75	50	621
500×500-500	500	500	500	660	590	1255	755	200	80	55	700
400×600-500	400	600	500	580	490	1460	960	300	90	60	1000
600×600-500	600	600	500	780	690	1460	960	300	90	60	1114
800×600-500	800	600	500	980	890	1460	960	300	90	60	1228
900×600-500	900	600	500	1080	990	1460	960	300	90	60	1285
1000×600-500	1000	600	500	1180	1090	1460	960	300	90	60	1342
1200×600-500	1200	600	500	1380	1290	1460	960	300	90	60	1456
600×900-500	600	900	500	800	680	1780	1280	300	100	80	1621
800×900-500	800	900	500	1000	880	1780	1280	300	100	80	1753
900×900-500	900	900	500	1100	980	1780	1280	300	100	80	1819
1000×900-500	1000	900	500	1200	1080	1780	1280	300	100	80	1885
1200×900-500	1200	900	500	1400	1280	1780	1280	300	100	80	2017
1500×900-500	1500	900	500	1700	1580	1780	1280	300	100	80	2215
2000×900-500	2000	900	500	2200	2080	1780	1280	300	100	80	2545



排水フリューム【茨城型】

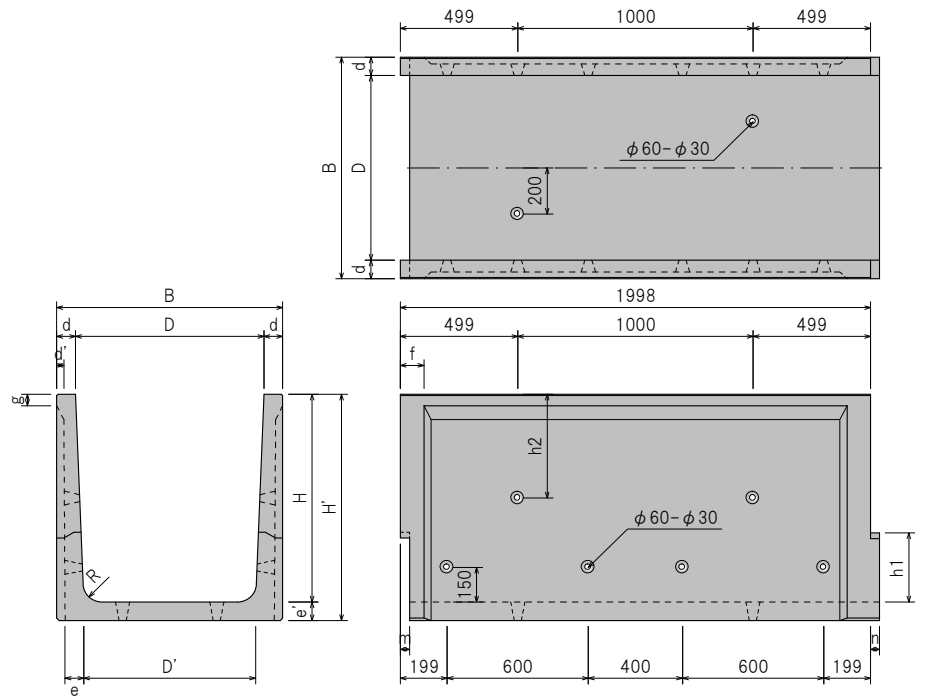
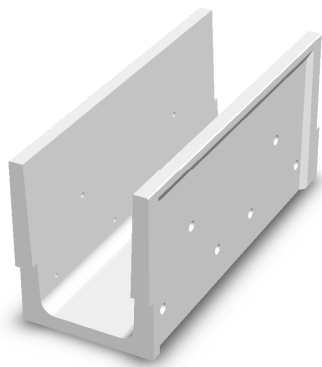

呼び名	寸法 (mm)																	参考重量 (kg)
	D	H	B	D'	H'	c	d	d'	e	e'	f	g	h1	h2	m	n	R	
400×400	400	400	520	370	450	80	60	20	50	50	70	40	150	—	30	28	50	298
400×600	400	600	540	360	660	80	70	20	60	60	70	50	200	—	30	28	60	471
600×600	600	600	740	560	660	150	70	20	60	60	70	50	200	—	30	28	60	528
800×600	800	600	940	760	660	200	70	20	60	60	70	50	200	—	30	28	60	586
600×900	600	900	760	530	980	150	80	30	80	80	100	50	300	450	40	38	80	867
800×900	800	900	960	730	980	200	80	30	80	80	100	50	300	450	40	38	80	942
1000×900	1000	900	1160	930	980	250	80	30	80	80	100	50	300	540	40	38	80	1017
600×1200	600	1200	760	506	1310	120	80	30	92	110	100	50	600	450	40	38	80	1334

※印の規格は当社オリジナル。



溝型柵渠(B型)・U型柵渠(B形)

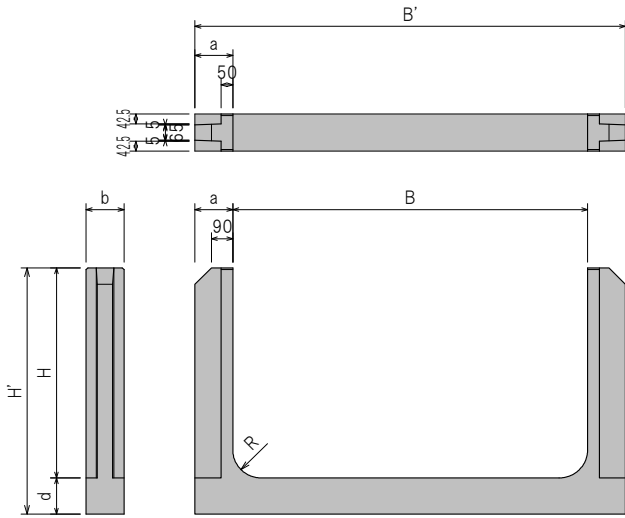
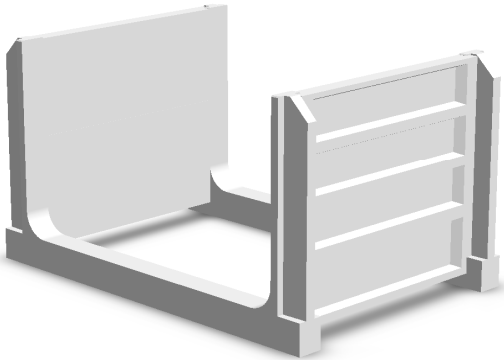

呼び名	寸法 (mm)								参考重量 (kg)
	B	H	B'	H'	a	b	d	R	
400×600	400	600	600	700	100	160	100	70	58
600×600	600	600	800	700	100	160	100	70	65
800×600	800	600	1000	700	100	160	100	70	72
1000×600	1000	600	1200	700	100	160	100	70	80
1200×600	1200	600	1400	700	100	160	100	70	88
600×900	600	900	920	1055	160	160	155	120	127
800×900	800	900	1120	1055	160	160	155	120	139
1000×900	1000	900	1320	1055	160	160	155	120	151
1200×900	1200	900	1520	1055	160	160	155	120	163
1500×900	1500	900	1820	1055	160	160	155	120	182
2000×900	2000	900	2320	1055	160	160	155	120	212
2500×900	2500	900	2820	1055	160	160	155	120	242
3000×900	3000	900	3320	1055	160	160	155	120	273
3500×900	3500	900	3820	1055	160	160	155	120	303
4000×900	4000	900	4320	1055	160	160	155	120	333
1000×1200	1000	1200	1420	1390	210	160	190	150	220
1200×1200	1200	1200	1620	1390	210	160	190	150	235
1500×1200	1500	1200	1920	1390	210	160	190	150	257
2000×1200	2000	1200	2420	1390	210	160	190	150	295
2500×1200	2500	1200	2920	1390	210	160	190	150	332
3000×1200	3000	1200	3420	1390	210	160	190	150	369
3500×1200	3500	1200	3920	1390	210	160	190	150	406
4000×1200	4000	1200	4420	1390	210	160	190	150	443
1000×1500	1000	1500	1540	1740	270	160	240	180	317
1200×1500	1200	1500	1740	1740	270	160	240	180	336
1500×1500	1500	1500	2040	1740	270	160	240	180	364
2000×1500	2000	1500	2540	1740	270	160	240	180	411
2500×1500	2500	1500	3040	1740	270	160	240	180	458
3000×1500	3000	1500	3540	1740	270	160	240	180	505
3500×1500	3500	1500	4040	1740	270	160	240	180	552
4000×1500	4000	1500	4540	1740	270	160	240	180	599
4500×1500	4500	1500	5040	1740	270	160	240	180	646
5000×1500	5000	1500	5540	1740	270	160	240	180	693

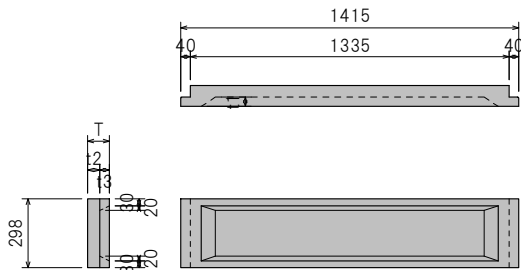

呼び名	寸法 (mm)				参考重量 (kg)
	T	t1	t2	t3	
300-90	90	40	50	40	62
300-100	100	50	50	50	66

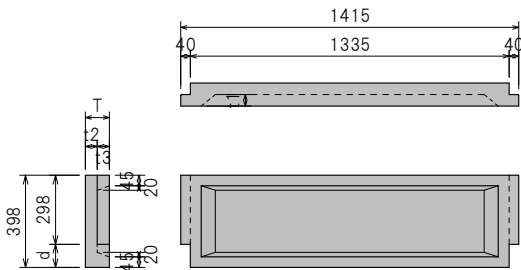

呼び名	寸法 (mm)					参考重量 (kg)
	T	t1	t2	t3	d	
400-100	100	50	50	50	100	83
455-100	100	50	50	50	155	100
490-100	100	50	50	50	190	111

※印のサイズは受注生産です。



U型フリューム

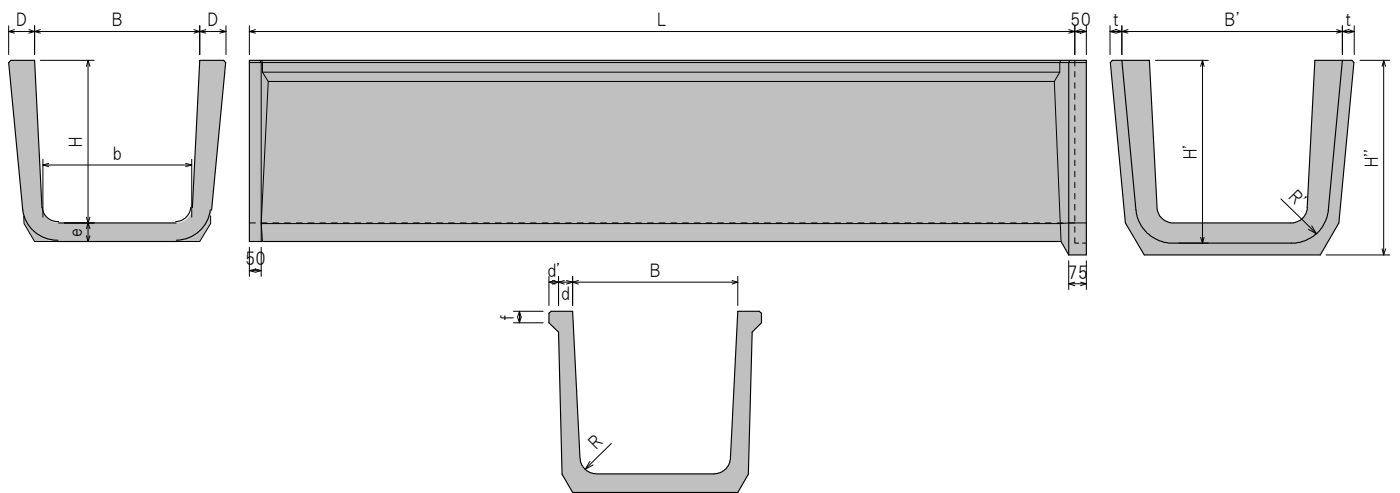
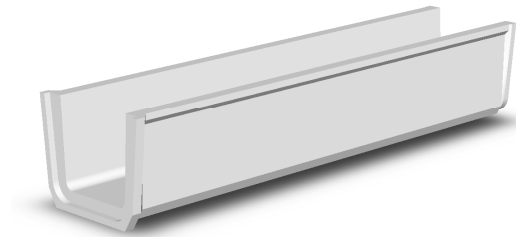

呼び名	寸法 (mm)															参考重量 (kg)
	B	b	D	H	L	d	d'	e	f	R	B'	H'	H''	t	R'	
300×300	300	270	70	300	3995	45	15	60	40	50	454	367	407	40	117	500
350×350	350	315	75	350	3995	45	20	60	40	50	514	417	457	40	117	574
400×400	400	360	85	400	3995	50	25	65	40	50	584	472	517	45	122	692
450×450	450	405	90	450	3995	50	25	65	40	50	644	522	567	45	107	766
500×500	500	405	90	500	3995	50	30	70	40	50	694	577	622	45	127	908
550×550	550	495	100	550	3995	50	40	70	40	50	764	627	672	45	127	995
600×600	600	540	110	600	3995	50	45	75	40	60	834	682	727	45	142	1291
700×700	700	630	110	700	3995	60	40	80	50	70	934	787	837	50	157	1636

※上記以外のサイズは、各営業所にお問い合わせ下さい。



L型水路【I種】

載荷重 $Q=10$
(kN/m²)

土の内部
摩擦角 $\phi=30$
(度)

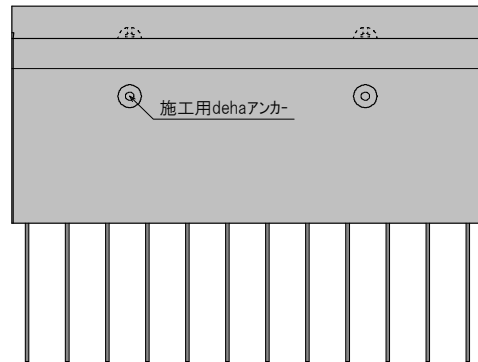
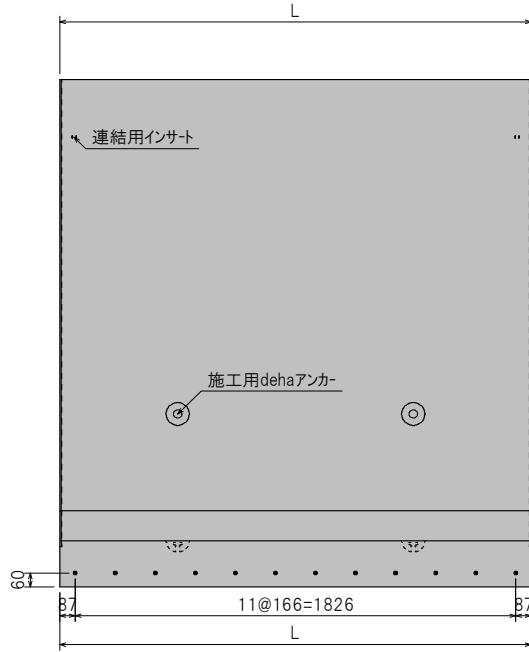
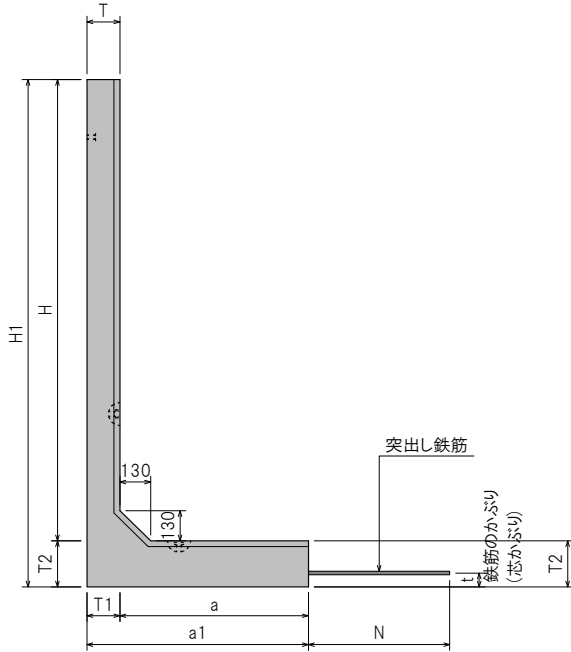

呼び名	寸法 (mm)										参考重量 (kg)	水路幅 (m)
	H	H1	L	a	a1	T	T1	T2	N	t		
800	800	920	2000	400	480	80	80	120	400以上	60	624	1.50~3.00
900	900	1020	2000	400	480	80	80	120	400以上	60	663	1.50~3.00
1000	1000	1120	2000	400	480	80	80	120	400以上	60	701	1.50~3.00
1100	1100	1220	2000	400	500	100	100	120	500以上	60	857	1.50~4.00
1200	1200	1320	2000	400	500	100	100	120	500以上	60	905	1.50~4.00
1300	1300	1420	2000	400	500	100	100	120	500以上	60	953	1.50~4.00
1400	1400	1520	2000	400	500	100	100	120	500以上	60	1001	1.50~4.00
1500	1500	1640	2000	500	620	120	120	140	600以上	60	1321	2.00~5.00
1600	1600	1740	2000	500	620	120	120	140	600以上	60	1379	2.00~5.00
1700	1700	1860	2000	500	620	120	120	160	600以上	60	1496	2.00~5.00
1800	1800	1960	2000	600	740	140	140	160	600以上	60	1818	2.00~5.00
1900	1900	2060	2000	600	740	140	140	160	600以上	60	1886	2.00~5.00
2000	2000	2160	2000	600	740	140	140	160	700以上	60	1953	2.00~5.00
2100	2100	2280	2000	600	740	140	140	180	700以上	60	2091	2.00~6.00
2200	2200	2380	2000	600	740	140	140	180	700以上	60	2158	2.00~6.00
2300	2300	2500	2000	700	860	160	160	200	700以上	60	2633	2.00~6.00
2400	2400	2600	2000	700	860	160	160	200	700以上	60	2709	2.00~6.00



L型水路【Ⅱ種】

載荷重 $Q=15$
(kN/m²)

土の内部
摩擦角 $\phi=25$
(度)

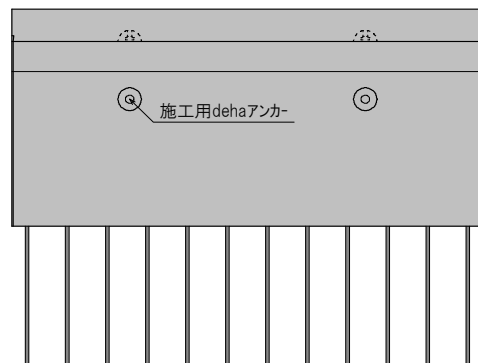
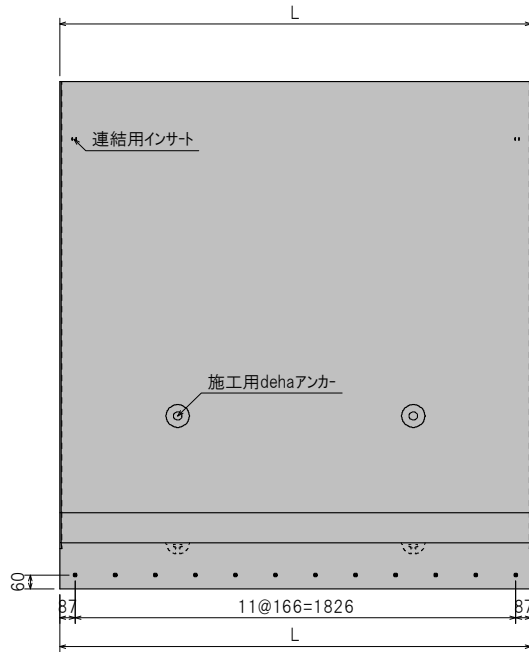
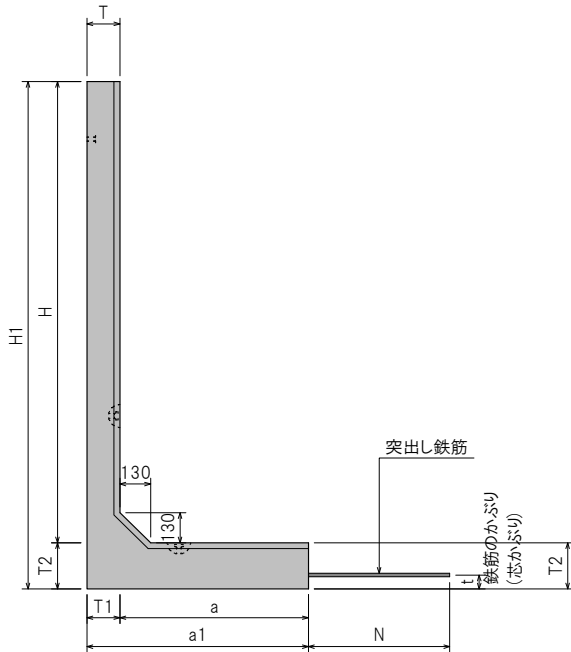

呼び名	寸法 (mm)										参考重量 (kg)	水路幅 (m)
	H	H1	L	a	a1	T	T1	T2	N	t		
800	800	920	2000	400	480	80	80	120	500以上	60	624	1.50~3.00
900	900	1020	2000	400	480	80	80	120	500以上	60	663	1.50~3.00
1000	1000	1120	2000	400	480	80	80	120	500以上	60	701	1.50~3.00
1100	1100	1240	2000	400	500	100	100	140	500以上	60	905	1.50~4.00
1200	1200	1340	2000	400	500	100	100	140	500以上	60	953	1.50~4.00
1300	1300	1440	2000	400	500	100	100	140	600以上	60	1001	1.50~4.00
1400	1400	1540	2000	400	500	100	100	140	600以上	60	1049	1.50~4.00
1500	1500	1660	2000	500	620	120	120	160	600以上	60	1381	2.00~5.00
1600	1600	1760	2000	500	620	120	120	160	600以上	60	1438	2.00~5.00
1700	1700	1860	2000	500	620	120	120	160	600以上	60	1496	2.00~5.00
1800	1800	1960	2000	600	740	140	140	160	600以上	60	1818	2.00~5.00
1900	1900	2060	2000	600	740	140	140	160	600以上	60	1886	2.00~5.00
2000	2000	2160	2000	600	740	140	140	160	600以上	60	1953	2.00~5.00
2100	2100	2300	2000	600	740	140	140	200	700以上	60	2162	2.00~6.00
2200	2200	2400	2000	600	740	140	140	200	700以上	60	2229	2.00~6.00
2300	2300	2500	2000	700	860	160	160	200	700以上	60	2633	2.00~6.00
2400	2400	2600	2000	700	860	160	160	200	700以上	60	2709	2.00~6.00