

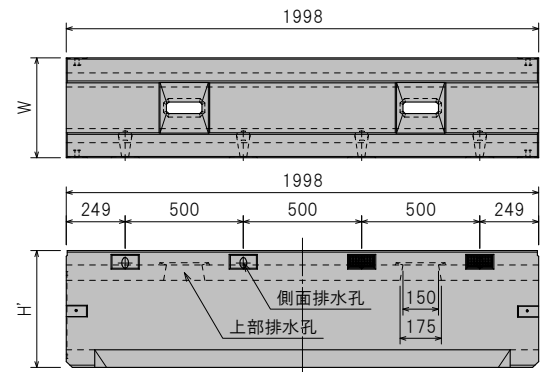

IBC排水側溝

【基本】

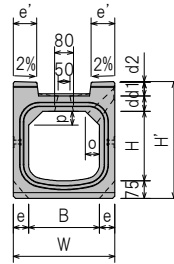
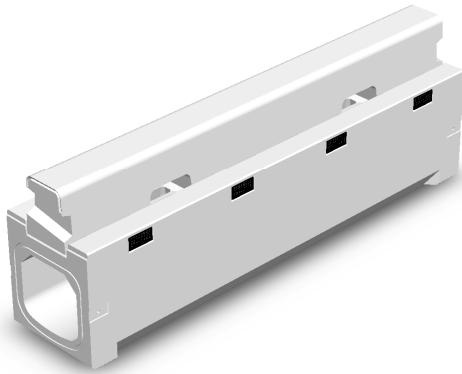

呼び名	寸法 (mm)												参考重量 (kg)
	B	H	W	H'	d	d1	d2	e	e'	f	o	p	
300×300	300	300	430	502	65	60	2	65	100	75	60	60	542
300×400	300	400	430	602	65	60	2	65	100	75	60	60	602
300×500	300	500	430	702	65	60	2	65	100	75	60	60	664
300×600	300	600	430	802	65	60	2	65	100	75	60	60	725
300×700	300	700	430	902	65	60	2	65	100	75	60	60	786

※上記以外のサイズは、各営業所にお問い合わせ下さい。

【施工概要図例】

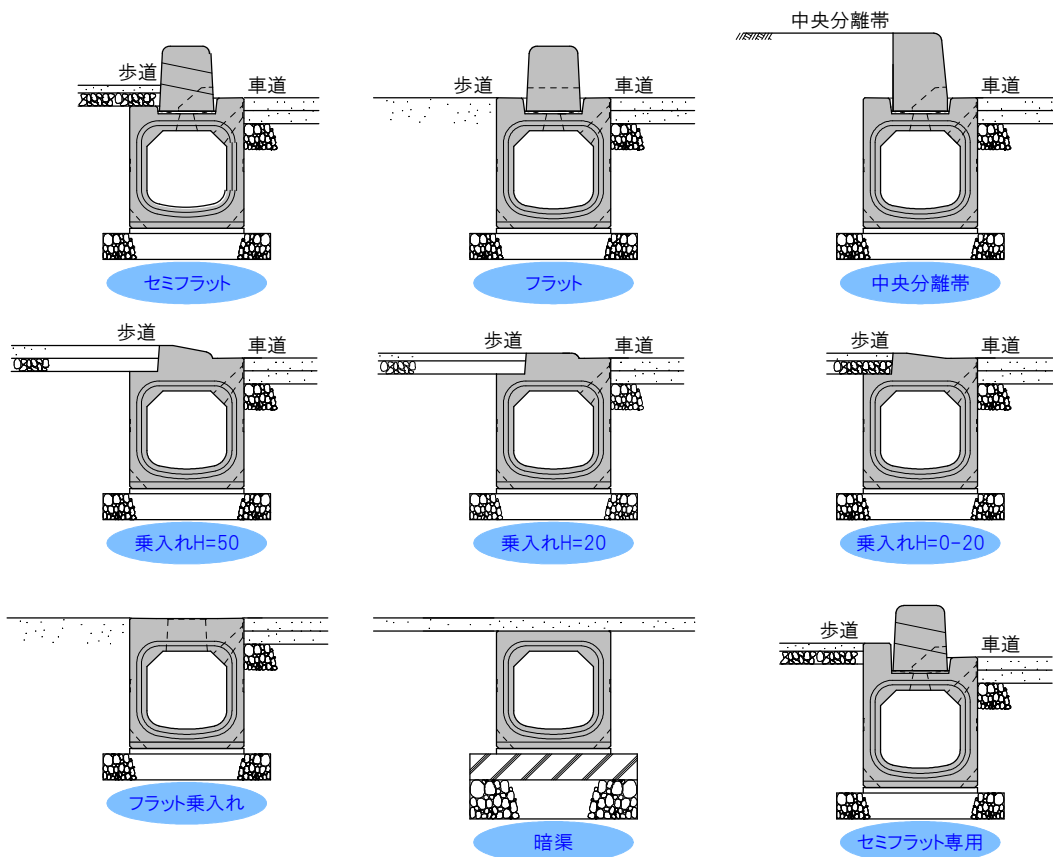

※乗入れには、基本と歩車道境界ブロックを組み合わせるタイプもあります。



IBC排水側溝

【歩車道境界ブロック】セミフラットB

B 基本

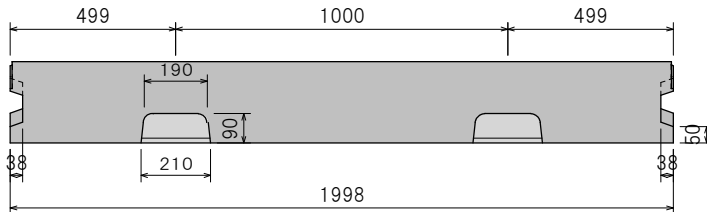
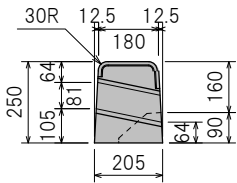

参考質量:211kg

B 斜 H=50

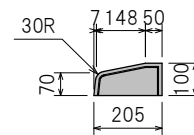
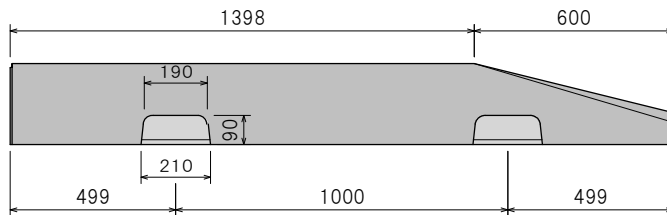
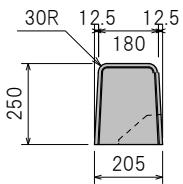

参考質量:191kg

B 斜 H=20

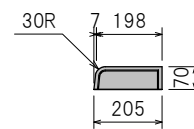
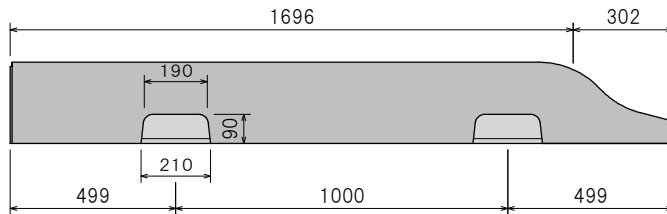
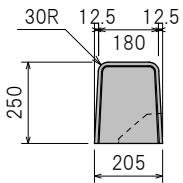

参考質量:200kg

B 斜 H=0-20

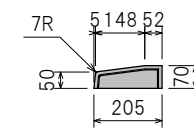
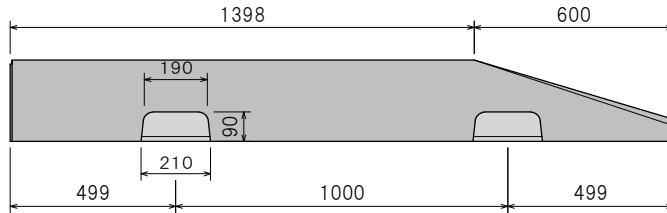
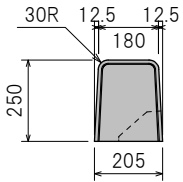

参考質量:188kg

※歩車道境界ブロックには、他にブロック高150のセミフラットAがあります。

フラット 基本

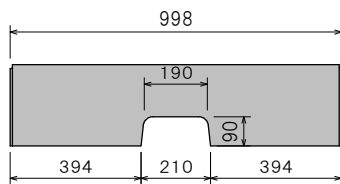
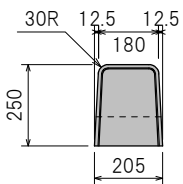

参考質量:103kg

フラット 斜

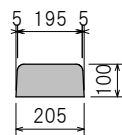
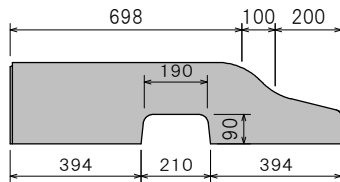
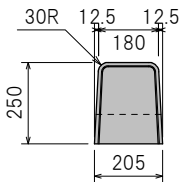

参考質量:91kg

中央分離帯用 C

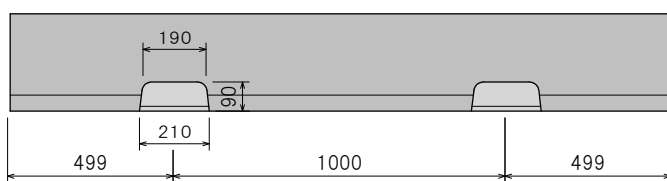
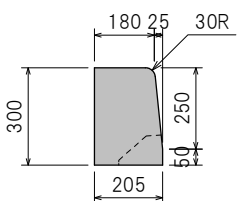

参考質量:259kg



アーバンU-V

縦断  
側圧 T-25

横断  
直載 T-6

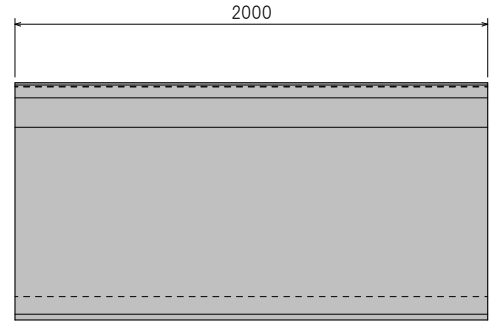
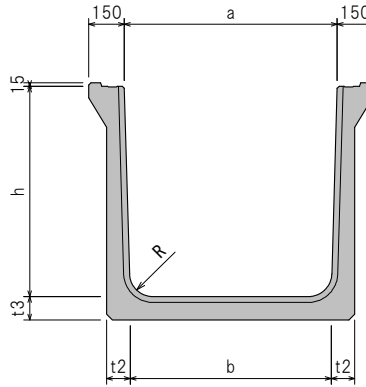
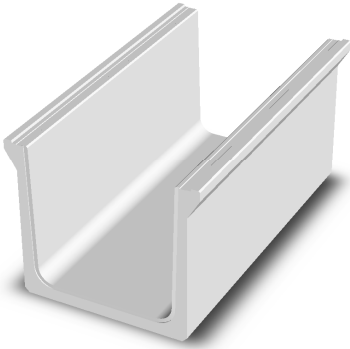

呼び名	寸法 (mm)						参考重量 (kg)
	a	h	b	t2	t3	R	
700×700	700	700	650	95	95	100	1049
700×800	700	800	650	95	95	100	1127
800×800	800	800	750	95	95	100	1174
800×900	800	900	750	100	100	100	1315
900×900	900	900	850	100	100	100	1363
1000×1000	1000	1000	930	110	110	150	1622
1200×1500	1200	1500	1100	160	160	250	3201



アーバンU-V 蓋

横断  
直載 T-6

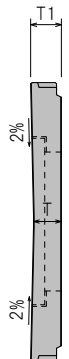
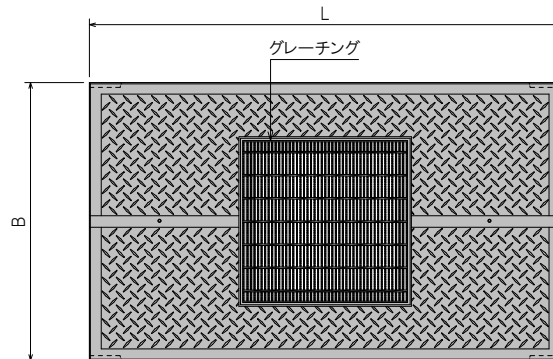
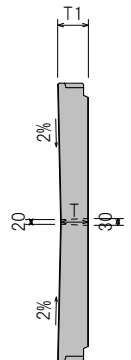
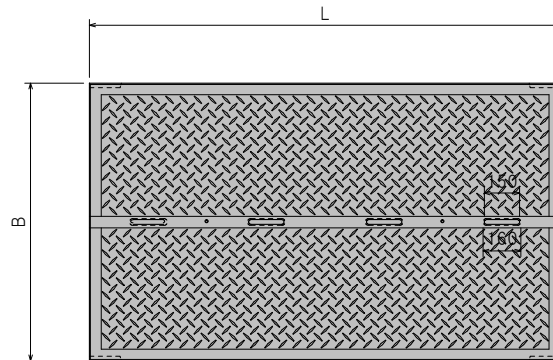
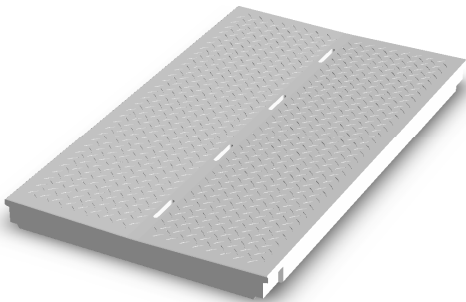

呼び名	寸法 (mm)				参考重量(kg)	
	B	L	T	T1	標準	グレーチングタイプ
700用	1000	2000	119	130	578	—
800用	1100	2000	119	130	640	—
900用	1200	2000	118	130	720	—
1000用	1300	2000	117	130	758	—
1200用	1500	2000	115	130	868	—

※スリットグレーチングタイプも製造可能です。



縦断  
側圧 T-25

横断  
直載 T-6

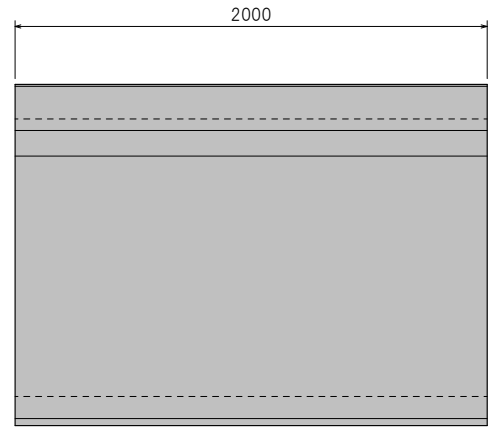
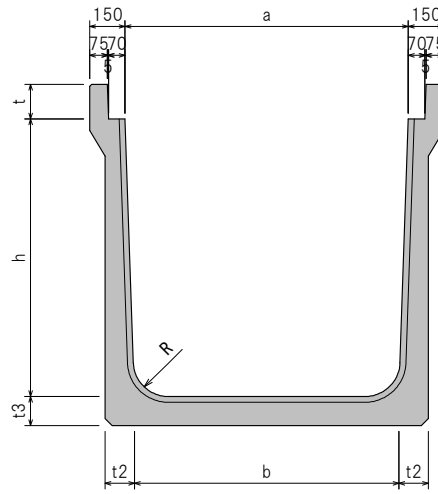
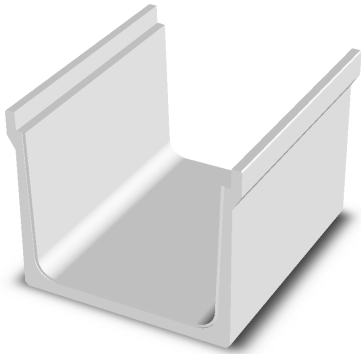

H=600

呼び名	寸法 (mm)							参考重量 (kg)
	a	h	b	t	t2	t3	R	
400×600	400	600	360	120	90	90	70	881
500×600	500	600	460	120	90	90	70	924
600×600	600	600	560	120	90	90	70	967
700×600	700	600	660	120	90	90	70	1010
800×600	800	600	760	120	90	90	70	1053
900×600	900	600	860	120	90	90	70	1096
1000×600	1000	600	960	150	90	90	70	1162
1100×600	1100	600	1060	150	90	90	70	1205
1200×600	1200	600	1160	150	90	90	70	1248

H=700

呼び名	寸法 (mm)							参考重量 (kg)
	a	h	b	t	t2	t3	R	
500×700	500	700	450	120	95	95	100	1040
600×700	600	700	550	120	95	95	100	1086
700×700	700	700	650	120	95	95	100	1132
800×700	800	700	750	120	95	95	100	1178
900×700	900	700	850	120	95	95	100	1224
1000×700	1000	700	950	150	95	95	100	1290
1100×700	1100	700	1050	150	95	95	100	1336
1200×700	1200	700	1150	150	95	95	100	1382
1300×700	1300	700	1250	150	95	95	100	1428
1400×700	1400	700	1350	150	95	95	100	1474
1500×700	1500	700	1450	150	95	95	100	1520
1600×700	1600	700	1550	150	95	95	100	1566
1700×700	1700	700	1650	150	95	95	100	1612
1800×700	1800	700	1750	150	95	95	100	1658
1900×700	1900	700	1850	150	95	95	100	1704
2000×700	2000	700	1950	150	95	95	100	1750

H=800

呼び名	寸法 (mm)							参考重量 (kg)
	a	h	b	t	t2	t3	R	
600×800	600	800	550	120	95	95	100	1165
700×800	700	800	650	120	95	95	100	1211
800×800	800	800	750	120	95	95	100	1257
900×800	900	800	850	120	95	95	100	1303
1000×800	1000	800	950	150	95	95	100	1369
1100×800	1100	800	1050	150	95	95	100	1415
1200×800	1200	800	1150	150	95	95	100	1461
1300×800	1300	800	1250	150	95	95	100	1507
1400×800	1400	800	1350	150	95	95	100	1553
1500×800	1500	800	1450	150	95	95	100	1599
1600×800	1600	800	1550	150	95	95	100	1645
1700×800	1700	800	1650	150	95	95	100	1691
1800×800	1800	800	1750	150	95	95	100	1737
1900×800	1900	800	1850	150	95	95	100	1783
2000×800	2000	800	1950	150	95	95	100	1829

H=900

呼び名	寸法 (mm)							参考重量 (kg)
	a	h	b	t	t2	t3	R	
600×900	600	900	550	120	100	100	100	1301
700×900	700	900	650	120	100	100	100	1349
800×900	800	900	750	120	100	100	100	1397
900×900	900	900	850	120	100	100	100	1445
1000×900	1000	900	950	150	100	100	100	1516
1100×900	1100	900	1050	150	100	100	100	1564
1200×900	1200	900	1150	150	100	100	100	1612
1300×900	1300	900	1250	150	100	100	100	1660
1400×900	1400	900	1350	150	100	100	100	1708
1500×900	1500	900	1450	150	100	100	100	1756
1600×900	1600	900	1550	150	100	100	100	1804
1700×900	1700	900	1650	150	100	100	100	1852
1800×900	1800	900	1750	150	100	100	100	1900
1900×900	1900	900	1850	150	100	100	100	1948
2000×900	2000	900	1950	150	100	100	100	1996



## アーバンU

H=1000

呼び名	寸法 (mm)							参考重量 (kg)
	a	h	b	t	t2	t3	R	
700×1000	700	1000	630	120	110	110	150	1545
800×1000	800	1000	730	120	110	110	150	1598
900×1000	900	1000	830	120	110	110	150	1651
1000×1000	1000	1000	930	150	110	110	150	1726
1100×1000	1100	1000	1030	150	110	110	150	1779
1200×1000	1200	1000	1130	150	110	110	150	1832
1300×1000	1300	1000	1230	150	110	110	150	1885
1400×1000	1400	1000	1330	150	110	110	150	1938
1500×1000	1500	1000	1430	150	110	110	150	1991
1600×1000	1600	1000	1530	150	110	110	150	2044
1700×1000	1700	1000	1630	150	110	110	150	2097
1800×1000	1800	1000	1730	150	110	110	150	2150
1900×1000	1900	1000	1830	150	110	110	150	2203
2000×1000	2000	1000	1930	150	110	110	150	2256

H=1100

呼び名	寸法 (mm)							参考重量 (kg)
	a	h	b	t	t2	t3	R	
800×1100	800	1100	730	120	115	115	150	1760
900×1100	900	1100	830	120	115	115	150	1815
1000×1100	1000	1100	930	150	115	115	150	1893
1100×1100	1100	1100	1030	150	115	115	150	1948
1200×1100	1200	1100	1130	150	115	115	150	2003
1300×1100	1300	1100	1230	150	115	115	150	2058
1400×1100	1400	1100	1330	150	115	115	150	2113
1500×1100	1500	1100	1430	150	115	115	150	2168
1600×1100	1600	1100	1530	150	115	115	150	2223
1700×1100	1700	1100	1630	150	115	115	150	2278
1800×1100	1800	1100	1730	150	115	115	150	2333
1900×1100	1900	1100	1830	150	115	115	150	2388
2000×1100	2000	1100	1930	150	115	115	150	2443

H=1200

呼び名	寸法 (mm)							参考重量 (kg)
	a	h	b	t	t2	t3	R	
800×1200	800	1200	720	120	125	125	150	1985
900×1200	900	1200	820	120	125	125	150	2045
1000×1200	1000	1200	920	150	125	125	150	2127
1100×1200	1100	1200	1020	150	125	125	150	2187
1200×1200	1200	1200	1120	150	125	125	150	2247
1300×1200	1300	1200	1220	150	125	125	150	2307
1400×1200	1400	1200	1320	150	125	125	150	2367
1500×1200	1500	1200	1420	150	125	125	150	2427
1600×1200	1600	1200	1520	150	125	125	150	2487
1700×1200	1700	1200	1620	150	125	125	150	2547
1800×1200	1800	1200	1720	150	125	125	150	2607
1900×1200	1900	1200	1820	150	125	125	150	2667
2000×1200	2000	1200	1920	150	125	125	150	2727
2100×1200	2100	1200	2020	180	125	125	150	2809
2200×1200	2200	1200	2120	180	125	125	150	2869

H=1300

呼び名	寸法 (mm)							参考重量 (kg)
	a	h	b	t	t2	t3	R	
900×1300	900	1300	810	120	140	140	150	2383
1000×1300	1000	1300	910	150	140	140	150	2473
1100×1300	1100	1300	1010	150	140	140	150	2540
1200×1300	1200	1300	1110	150	140	140	150	2607
1300×1300	1300	1300	1210	150	140	140	150	2674
1400×1300	1400	1300	1310	150	140	140	150	2741
1500×1300	1500	1300	1410	150	140	140	150	2808
1600×1300	1600	1300	1510	150	140	140	150	2875
1700×1300	1700	1300	1610	150	140	140	150	2942
1800×1300	1800	1300	1710	150	140	140	150	3009
1900×1300	1900	1300	1810	150	140	140	150	3076
2000×1300	2000	1300	1910	150	140	140	150	3143
2100×1300	2100	1300	2010	180	140	140	150	3234
2200×1300	2200	1300	2110	180	140	140	150	3301
2300×1300	2300	1300	2210	180	140	140	150	3368

H=1400

呼び名	寸法 (mm)							参考重量 (kg)
	a	h	b	t	t2	t3	R	
1000×1400	1000	1400	910	150	150	150	150	2783
1100×1400	1100	1400	1010	150	150	150	150	2855
1200×1400	1200	1400	1110	150	150	150	150	2927
1300×1400	1300	1400	1210	150	150	150	150	2999
1400×1400	1400	1400	1310	150	150	150	150	3071
1500×1400	1500	1400	1410	150	150	150	150	3143
1600×1400	1600	1400	1510	150	150	150	150	3215
1700×1400	1700	1400	1610	150	150	150	150	3287
1800×1400	1800	1400	1710	150	150	150	150	3359
1900×1400	1900	1400	1810	150	150	150	150	3431
2000×1400	2000	1400	1910	150	150	150	150	3503
2100×1400	2100	1400	2010	180	150	150	150	3598
2200×1400	2200	1400	2110	180	150	150	150	3670
2300×1400	2300	1400	2210	180	150	150	150	3742
2400×1400	2400	1400	2310	180	150	150	150	3814

H=1500

呼び名	寸法 (mm)							参考重量 (kg)
	a	h	b	t	t2	t3	R	
1000×1500	1000	1500	900	150	160	160	250	3152
1100×1500	1100	1500	1000	150	160	160	250	3229
1200×1500	1200	1500	1100	150	160	160	250	3306
1300×1500	1300	1500	1200	150	160	160	250	3383
1400×1500	1400	1500	1300	150	160	160	250	3460
1500×1500	1500	1500	1400	150	160	160	250	3537
1600×1500	1600	1500	1500	150	160	160	250	3614
1700×1500	1700	1500	1600	150	160	160	250	3691
1800×1500	1800	1500	1700	150	160	160	250	3768
1900×1500	1900	1500	1800	150	160	160	250	3845
2000×1500	2000	1500	1900	150	160	160	250	3922
2100×1500	2100	1500	2000	180	160	160	250	4019
2200×1500	2200	1500	2100	180	160	160	250	4096
2300×1500	2300	1500	2200	180	160	160	250	4173
2400×1500	2400	1500	2300	180	160	160	250	4250
2500×1500	2500	1500	2400	180	160	160	250	4327
2600×1500	2600	1500	2500	180	160	160	250	4404
2700×1500	2700	1500	2600	180	160	160	250	4481



## アーバンU 蓋

横断	T-6
直載	

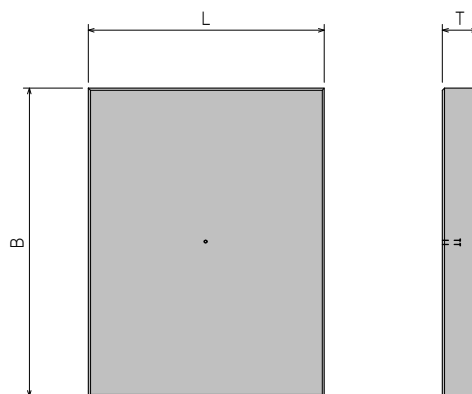
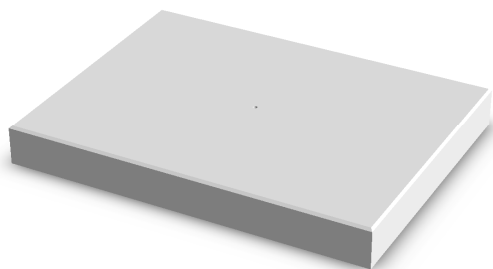

呼び名	寸 法 (mm)			参考重量 (kg)
	B	L	T	
600 用	730	1000	120	210
700 用	830	1000	120	239
800 用	930	1000	120	268
900 用	1030	1000	120	297
1000 用	1130	1000	150	406
1100 用	1230	1000	150	443
1200 用	1330	1000	150	479
1300 用	1430	1000	150	515
1400 用	1530	1000	150	551
1500 用	1630	1000	150	587
1600 用	1730	1000	150	623
1700 用	1830	1000	150	659
1800 用	1930	1000	150	695
1900 用	2030	1000	150	731
2000 用	2130	1000	150	767
2100 用	2230	1000	180	963
2200 用	2330	1000	180	1007
2300 用	2430	1000	180	1050
2400 用	2530	1000	180	1093
2500 用	2630	1000	180	1136
2600 用	2730	1000	180	1179
2700 用	2830	1000	180	1223